

Single Pole (One location) or 3-Way (Multi-location)  
0-10V LED/Fluorescent Digital Dimmer

Cat. No. DD710-BD, 120/277V, 950VA (120V), 1350VA (277V)

For use with fixtures using 0-10V dimmable power supply/drivers, Advance Transformer Mark 7®, OSRAM Sylvania QUICKTRONIC®, Helios™ or equivalent dimmable ballasts

INSTALLATION INSTRUCTIONS

WARNINGS AND CAUTIONS:

- **TO AVOID FIRE, SHOCK, OR DEATH; TURN OFF POWER** at circuit breaker or fuse and test that power is off before wiring!
- **TO AVOID FIRE, PERSONAL INJURY OR PROPERTY DAMAGE, DO NOT** install to control a receptacle, a motor- or a transformer-operated appliance.
- To be installed and/or used in accordance with electrical codes and regulations.
- If you are unsure about any part of these instructions, consult an electrician.
- **TO AVOID FIRE, SHOCK, OR DEATH; USE ONLY WITH** appropriate LED 0-10V dimmable power supplies/drivers, Advance Transformer 120/277V Mark 7® 0-10V ballasts or OSRAM Sylvania QUICKTRONIC® or Helios™ electronic ballasts.
- The Decora® DD710 dimmer is not compatible with standard 3-way or 4-way switches. It must be used with a Decora Digital remote for multi-location control, such as the DD00R-DL.

WARNINGS AND CAUTIONS:

- Maximum wire length from dimmer to all installed remotes cannot exceed 300 ft.
- Dimmer may feel warm to the touch during normal operation.
- When retrofitting dimming ballasts into fixtures that originally had Instant Start ballasts, the sockets **MUST** be replaced with Rapid Start sockets to allow proper dimmer operation and to prevent damage to the dimming ballast. Refer to the instructions provided with the ballast.
- Recommended minimum wall box depth is 2-3/4".
- Use this device **WITH COPPER OR COPPER CLAD WIRE ONLY**.

INTRODUCTION

The next generation of lighting control technology is here with the new Decora Digital dimmer with Bluetooth® technology. This innovative device works using the Leviton Decora Digital Dimmer & Timer app that can be easily downloaded to smartphones or tablets and paired to the Leviton dimmer using Bluetooth® technology. Decora Digital devices give users point-to-point local control to automate lighting, bridging the gap between standard dimmers and whole-house automation systems. The Decora Digital dimmer is a powerful device – combining the best of Leviton dimmer and timer functions with today’s mobile technology for impressive results. The simple touch of a finger following the intuitive on-screen guide makes it more convenient than ever to manage lighting for home activities or to ensure a “lived-in” look while away.

Use of the app allows greater flexibility for accurate timer functionality and makes pushing buttons for timed events a tedious chore of the past.

The Leviton Decora Digital Dimmer & Timer app can be easily downloaded to mobile devices and is compatible with Android and iOS smartphones or tablets. The app is easy to use with simple, intuitive on-screen menu options to independently control dimmers and switches throughout the home.

Decora Digital devices are ideal for living rooms, bedrooms, kitchens, dining rooms, home offices, outdoor lighting or anywhere full control of lighting is desired.

Compatibility:

Requires device with Bluetooth® 4.0 (BT LE) or later and iOS 6.0 and later. Compatible with iPhone, iPad, and iPod touch or Android 4.0 and later.

FEATURES

- Soft fade ON/OFF
- ON/OFF LED and Brightness level LED
- Three way communication
- Ease of installation – No new wiring

TOOLS NEEDED TO INSTALL YOUR DIMMER

- Slotted/Phillips Screwdriver
- Electrical Tape
- Pliers
- Pencil
- Cutters
- Ruler

Changing the color of your Dimmer:

Your device may include color options. To change color of the face proceed as follows:

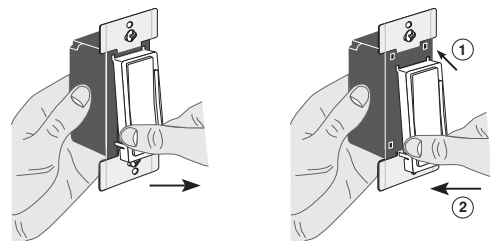

Push in sides at bottom tabs and pull outward to release

Insert top tabs and press in bottom tabs to attach

INSTALLING DIMMER BY ITSELF OR WITH OTHER DEVICES

NOTE: No derating is required in multi-device applications.

MAXIMUM BULB WATTAGE

0-10VDC ballasts are rated in Volt-Amps (VA). The maximum number of ballast per dimmer is based on the load VA rating. The maximum bulb wattage is determined by the efficiency of the ballast. Ballast efficiencies will vary from different manufacturers; consider 80% efficient as average. Use the chart to determine maximum bulb wattage for typical ballast efficiency ratings.

MAXIMUM BULB WATTAGE AT 80% EFFICIENCY				
Volts	Rating	Single	Two Devices	More than 2 Devices
120V	950VA	760VA	760VA	760VA
277V	1350VA	1080VA	1080VA	1080VA

INSTALLING YOUR DIMMER

NOTE: Use check boxes  when Steps are completed.

**Step 1** WARNING: TO AVOID FIRE SHOCK OR DEATH; TURN OFF POWER at circuit breaker or fuse and test that power is off before wiring!

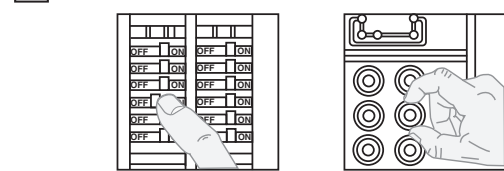

**Step 2** Identifying your wiring application (most common):

NOTE: If the wiring in your wall box does not resemble any of these configurations, consult an electrician.

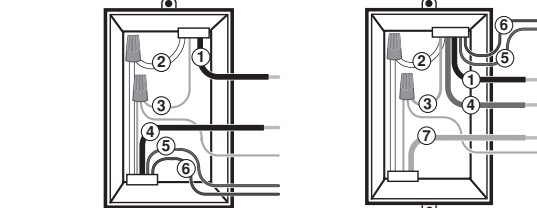

Single Pole

1. Line (Hot)
2. Neutral
3. Ground
4. Load
5. Violet (+)
6. Gray (-)

3-Way

1. Line (Hot)
2. Neutral
3. Ground
4. Load
5. Violet (+)
6. Gray (-)
7. Yellow/Red

**Step 3** Preparing and connecting wires:

Pull off pre-cut insulation from dimmer leads. Make sure that the ends of the wires from the wall box are **straight (cut if necessary)**. Remove insulation from each wire in the wall box as shown:

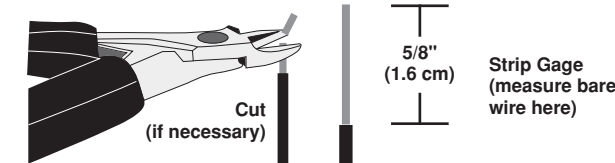

- Pull off pre-cut insulation from dimmer leads.
- Make sure that the ends of the wires from the wall box are **straight (cut if necessary)**.
- Remove insulation from each wire in the wall box as shown.
- **For Single-Pole Application, go to Step 4a.**
- **For 3-Way Matching Remote (w/LEDs) Application, go to Step 4b.**

For non-standard wiring applications, refer to Wire Connector and Conductor Size Chart

WIRE CONNECTOR / # OF COND. COMBINATION CHART

- 1 - #12 w/ 1 to 3 #14, #16 or #18
- 2 - #12 w/ 1 or 2 #16 or #18
- 1 - #14 w/ 1 to 4 #16 or #18
- 2 - #14 w/ 1 to 3 #16 or #18

**Step 4a** Single Pole Wiring Application:

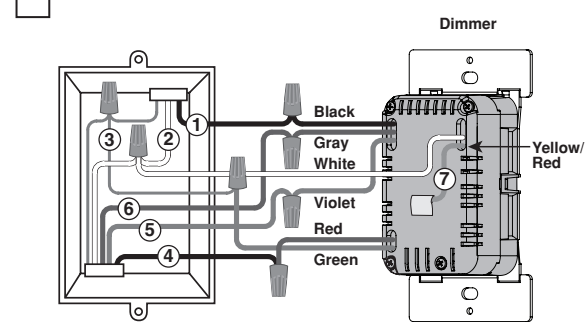

Wiring Diagram 1

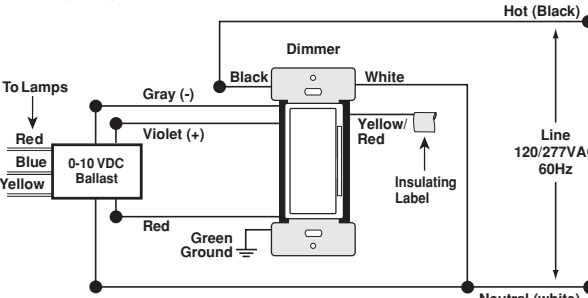

Connect wires per WIRING DIAGRAM as follows:

- Green or bare copper wall box wire to **GREEN** dimmer lead.
  - Line Hot wall box wire to **BLACK** dimmer lead.
  - Load wall box wire to **RED** dimmer lead.
  - Remaining **RED** Dimmer lead should have a label affixed.
  - Line Neutral wall box wire to **WHITE** dimmer lead.
  - **DO NOT REMOVE** this label in a single pole application.
  - **NOTE:** If the insulating label is not affixed to the second **RED** lead use electrical tape or a wire connector to cover.
  - Violet dimmer lead to (+) Violet connection on ballast.
  - Gray dimmer lead to (-) Gray connection on ballast.
- Proceed to Step 5.**

**Step 4b** 3-Way Wiring with DD00R Matching Remote (w/LEDs) Application:

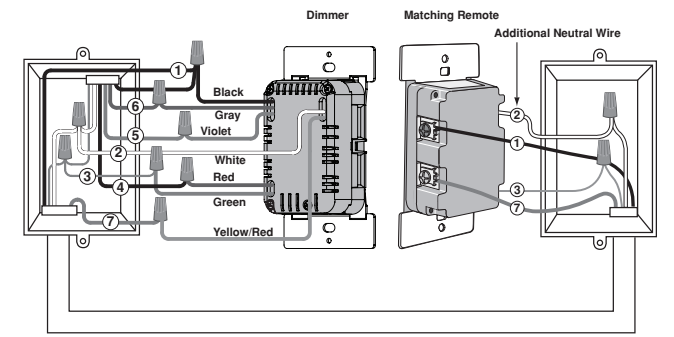

Wiring Diagram 2

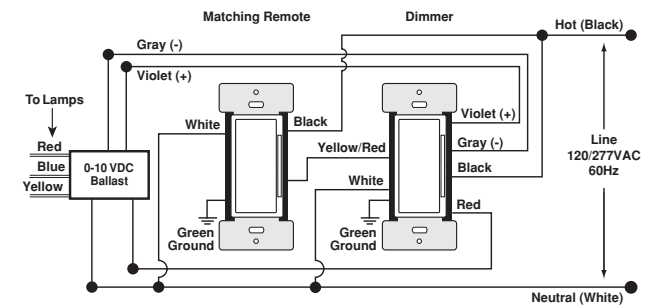

WIRING MATCHING REMOTE (wall box with line hot connection):

Connect wires per WIRING DIAGRAM as follows:  
NOTE: The matching remote must be installed in a wall box with a Line Hot connection and a Neutral connection. A Neutral wire to the matching remote needs to be added as shown.

NOTE: Maximum wire length from dimmer to all installed remotes cannot exceed 300 ft (90 m).

- Green or bare copper wire in wall box to Green terminal screw.
- Line Hot (common) wall box wire identified (tagged) when removing old switch and First Traveler to Remote terminal marked "BK".
- Second Traveler wall box wire from dimmer to remote terminal screw marked "YL/RD" (**note wire color**). This traveler from the remote must go to Yellow/Red dimmer lead.
- Line Neutral wall box to remote terminal screw marked "WH".

WIRING DIMMER (wall box with load connection):

Connect wires per WIRING DIAGRAM as follows:  
NOTE: The DD710 dimmer **must** be installed in a wall box that has a Load connection and a Neutral connection.

- Green or bare copper wire in wall box to Green dimmer lead.
  - Load wall box wire identified (tagged) when removing old switch to Red dimmer lead.
  - First Traveler Line Hot to Black dimmer lead.
  - Remove Red insulating label from Yellow/Red dimmer lead.
  - Second Traveler wall box wire (**note color as above**) to Yellow/Red dimmer lead. This traveler from the dimmer must go to the terminal screw on the remote marked "YL/RD".
  - Line neutral wall box wire to White dimmer lead.
- Proceed to Step 5.**

### Step 5 Testing your Dimmer prior to mounting in wall box:

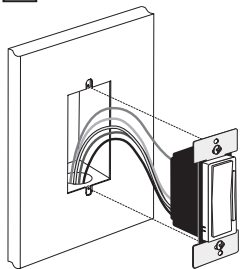

- Position all wires to provide room in outlet wall box for device.
  - Ensure that the word "TOP" is facing up on device strap.
  - Partially screw in mounting screws in wall box mounting holes.
- NOTE:** Dress wires with a bend as shown in diagram in order to relieve stress when mounting device.

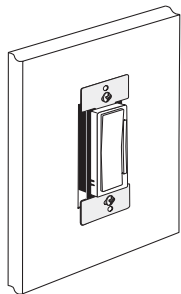

- Restore power at circuit breaker or fuse.
- Press pad until locator light is OFF. Lights should turn ON. If lights do not turn ON, press the TOP half of the DIM/BRIGHT Bar until the lights brighten.

If lights still do not turn ON, refer to the TROUBLESHOOTING section.

### Step 6 Dimmer Mounting: TURN OFF POWER AT CIRCUIT BREAKER OR FUSE.

Installation may now be completed by tightening mounting screws into wall box. Attach wallplate.

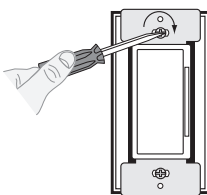

### Step 7 Restore Power:

Restore power at circuit breaker or fuse. Installation is complete.

**NOTE:** To pair your dimmer with your mobile device, download the Leviton Decora Digital Dimmer and Timer app from the Google Play Store or your iTunes account. Contact Leviton's Techline at 1-800-824-3005 or visit Leviton's website at [www.leviton.com](http://www.leviton.com) for additional information.

### OPERATION

**NOTE:** The locator light will illuminate when the load is in the OFF position to facilitate access in the dark.

**NOTE:** If using the dimmer in a 3-way application, the lights will turn ON at brightness set on dimmer's DIM/BRIGHT bar. The lighting can be controlled from either the dimmer, the remote location or the mobile device app.

#### Push Pad (Default settings)

**Turn ON from OFF position:**  
Tap TOP of Rocker: Lights turn ON to preset level.

**Turn OFF from ON position:**  
Tap BOTTOM of Rocker. Lights turn OFF.

#### DIM/BRIGHT Bar

**BRIGHTEN:**  
Press the TOP half of the DIM/BRIGHT Bar – Lights brighten to desired level.

#### DIM:

Press the BOTTOM half of the DIM/BRIGHT Bar – Lights dim to desired level. If you continue to hold, the lights will DIM to minimum level and then turn OFF.

**NOTE:** When lights are OFF you can change the light level that the lights will turn ON to using the DIM/BRIGHT Bar. If there is a power outage, when the power is restored, the lights will return to the last setting before the power interruption.

**Cleaning:** Clean with a damp cloth. DO NOT use chemical cleaners.

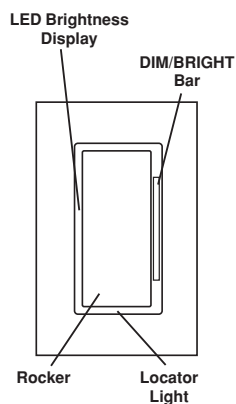

### ADVANCED PROGRAMMING FEATURES

#### Definition of A Modes

**A-1) Maximum Brightness Level:** Sets the maximum brightness level for energy savings.

**A-2) Minimum Brightness Level:** Sets the minimum dimming level.

**A-3) Preset ON Level:** Sets the turn on brightness level regardless of the previous set light level.

#### Definition of B Modes

**B-1) ON Fade Rate:** Sets the amount of time in seconds it takes the lights to turn ON to maximum brightness.

**B-2) OFF Fade Rate:** Sets the amount of time in seconds it takes the lights to turn OFF from maximum brightness.

**B-3) LED Options:** Sets the time period in seconds the Locator LED and Brightness display will stay on before extinguishing.

#### Definition of LEDs

Bottom LED = LED 1  
Top LED = LED 7

#### NOTES:

- The device will exit programming mode after 3 minutes of inactivity.
- Pressing the TOP of the Rocker at any time during programming will advance the device to the next programming mode.

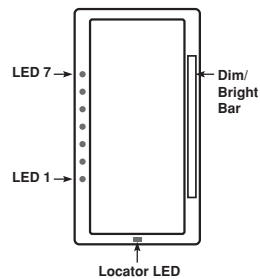

#### Program Mode A

##### To enter Program Mode A:

Press and hold the TOP of the Rocker and the TOP of the DIM/BRIGHT Bar simultaneously for 5 seconds until the Locator LED begins to blink.

**A-1) Maximum Brightness Level:** NOTE - The Locator LED will blink once per second to indicate the device is in Program Mode **A-1, Maximum Brightness Level**. The default Maximum Brightness Level is LED 7, representing 100% light output i.e. full brightness. To change the Maximum Brightness level from 100% to the desired output level, use the DIM/BRIGHT bar. The Maximum Brightness level can be changed from LED 7, representing maximum light output, to LED 4, representing minimum light output. By tapping the TOP of the Rocker this setting will automatically be saved and the device will advance to the next Programming Mode, **A-2, Minimum Brightness Level**.

**A-2)** The Locator LED will blink 2 times per second to indicate the device is in Program Mode **A-2, Minimum Brightness Level**. The default Minimum Brightness Level is LED 2. To change the **Minimum Brightness Level** from 1-50%, use the DIM/BRIGHT Bar. The light output will reflect the minimum brightness level selected. By tapping the TOP of the Rocker this setting will automatically be saved and the device will advance to the next programming mode, **A-3, Preset ON Level**.

**A-3)** The Locator LED will blink 3 times per second to indicate Program Mode **A-3, Preset ON Level**. To change the current **Preset ON Level** from 1-100%, use the DIM/BRIGHT Bar. If this feature is not desired, press and hold the BOTTOM half of the DIM/BRIGHT Bar until LED 1 is lit, and then keep holding for another two seconds. By tapping the TOP of the Rocker this setting will automatically be saved and the device will exit Programming Mode **A**.

#### Program Mode B

##### To enter Program Mode B:

Press and hold the TOP of the Rocker and then the BOTTOM of the DIM/BRIGHT Bar for 5 seconds until the Locator LED and the TOP LED (LED 7) begin to blink.

**B-1)** Upon releasing the TOP of the Rocker and the BOTTOM of the DIM/BRIGHT Bar, the Locator LED will continue to blink once per second indicating the dimmer is in Program Mode **B-1, ON Fade Rate**. To change the **ON Fade Rate**, use the DIM/BRIGHT Bar to move the LED to the desired preset level according to the **Fade Rate Chart**. By tapping the Top of the Rocker this setting will automatically be saved and the device will advance to the next programming mode, **B-2, OFF Fade Rate**.

**B-2)** The Locator LED will blink 2 times per second to indicate Program Mode **B-2, OFF Fade Rate**. To change the **OFF Fade Rate**, use the DIM/BRIGHT Bar to move the LED to the desired preset level according to the **Fade Rate Chart**. By tapping the TOP of the Rocker this setting will automatically be saved and the device will advance to the next programming mode, **B-3 LED Options**.

FADE RATE CHART		
LED	Fade ON	Fade OFF
1	0 seconds (instant)	0 seconds (instant)
2	0.5 seconds	0.5 seconds
3	1.5 seconds	1.5 seconds
4	3 seconds	3 seconds
5	6 seconds	6 seconds
6	10 seconds	10 seconds
7	25 seconds	25 seconds

**B-3)** The Locator LED will blink 3 times per second to indicate Program Mode **B-3, LED Options**. To change the **LED Options** settings, use the DIM/BRIGHT Bar to move the LED to the desired preset setting according to the **LED Options Chart**. By tapping the Top of the Rocker this setting will automatically be saved and the device will exit Programming Mode B.

LED OPTIONS CHART		
LED	Locator LED Timeout	LED Brightness Display Options
1	Active	Active
2	Active	Turns OFF 5 seconds after use
3	Turns OFF 5 seconds after use	Active
4	Turns OFF 5 seconds after use	Turns OFF 5 seconds after use
5	N/A	N/A
6	N/A	N/A
7	N/A	N/A

### CONTROLLING YOUR DIMMER WITH BLUETOOTH®

#### Download the Leviton Decora Digital Dimmer & Timer App for your device.

**Android:** Tap the Google Play Store icon on your phone or go to <http://play.google.com> on your computer and follow the instructions to obtain the app.

**iPhone:** Tap the App Store icon on your phone or access the app through your iTunes account on your computer.

Once you have downloaded the app, follow the instructions on the screen to pair your mobile device with your dimmer. Once your mobile device is paired, use the following options to control your dimmer:

- On - Off:** Turns the dimmer ON and OFF.
- Schedule:** Creates distinct ON/OFF events based on time and day.
- Sleep Timer:** Sets countdown to turn dimmer OFF.

#### Advanced Settings

##### Device Options

- Randomized Scheduled Events:** Cycles lights ON and OFF to ensure a "lived-in" look while away.
- Hide LED Dim Bar:** Turns LED Dim Bar OFF.
- Hide Status LED:** Turns Status LED OFF.
- DST Offset Hours:** Adjusts the Sunrise/Sunset time in hours.
- DST Offset Minutes:** Adjusts the Sunrise/Sunset time in minutes.

##### Bulb Options

- Fade On:** Sets the amount of time for the lights to turn ON to maximum brightness.
- Fade Off:** Sets the amount of time for the lights to turn to OFF from maximum brightness.

##### Lighting Options

- Preset:** Sets the brightness level at which the lights turn ON.
- Minimum:** Sets a minimum brightness level for lighting.
- Maximum:** Sets a maximum brightness level for lighting.

### TROUBLESHOOTING

- Lights Flickering**
  - Lamp has a bad connection.
  - Wires not secured firmly with wire connectors of dimmer or terminal screws of remote.
- Light does not turn ON and Locator LED does not turn ON**
  - Circuit breaker or fuse has tripped.
  - Lamp is burned out.
  - Neutral not wired to Dimmer (White wire).
  - Confirm that the device is being supplied from a 120V or 277V, 60 Hz AC source ONLY.
- Intermittent dimmer operation**
  - Confirm that the Load being controlled does not exceed 950VA at 120VAC or 1350VA at 277VAC.
- Remote does not operate lights**
  - Ensure that total wire length does not exceed 300 ft.
  - Ensure wiring is correct.

### FACTORY DEFAULT

If your dimmer is not responding, or you are unable to control it after you have tried to Pair/Connect to it multiple times, it is necessary to reset the dimmer to its original factory settings. To accomplish this, proceed as follows:

On the dimmer, hold the TOP of the rocker until the locator LED starts to blink. The dimmer is now reset. Once the dimmer is reset, it is necessary to re-pair it with the your application.

For additional information, contact Leviton's Techline at 1-800-824-3005 or visit Leviton's website at [www.leviton.com](http://www.leviton.com)

This product is covered by U.S. Patent No. 8,664,886, 9,329,607, 9,398,667 and corresponding foreign patents.

### FCC COMPLIANCE STATEMENT

This device complies with Part 15 of the FCC Rules. Operation is subject to following two conditions: (1) this device may not cause harmful interference, and (2) this device must accept any interference received, including interference that may cause undesired operation of the device.

This equipment has been tested and found to comply with the limits for a Class B Digital Device, pursuant to Part 15 of the FCC Rules. These limits are designed to provide reasonable protection against harmful interference in a residential installation. This equipment generates, uses, and can radiate radio frequency energy and, if not installed and used in accordance with the instructions, may cause harmful interference to radio communications. However, there is no guarantee that interference will not occur in a particular installation. If this equipment does cause harmful interference to radio or television reception, which can be determined by turning the equipment OFF and ON, the user is encouraged to try to correct the interference by one or more of the following measures:

- Reorient or relocate the receiving Antenna.
- Increase the separation between the equipment and the receiver.
- Connect the equipment into an outlet on a circuit different from that to which the receiver is connected.
- Consult the dealer or an experienced radio/tv technician for help.

#### FCC CAUTION

Any changes or modifications not expressly approved by Leviton Manufacturing Co., Inc., could void the user's authority to operate the equipment.

### IC COMPLIANCE STATEMENT

This device complies with Industry Canada licence-exempt RSS standard(s). Operation is subject to the following two conditions: (1) this device may not cause interference, and (2) this device must accept any interference, including interference that may cause undesired operation of the device.

#### Copyright and Trademark Information

The Bluetooth® word mark and logos are registered trademarks owned by Bluetooth SIG, Inc., used under license by Leviton. Use herein of third party trademarks, service marks, trade names, brand names and/or product names are for informational purposes only, are/may be the trademarks of their respective owners; such use is not meant to imply affiliation, sponsorship, or endorsement. No part of this document may be reproduced, transmitted or transcribed without the express written permission of Leviton Manufacturing Co., Inc.

### FOR CANADA ONLY

For warranty information and/or product returns, residents of Canada should contact Leviton in writing at **Leviton Manufacturing of Canada Ltd to the attention of the Quality Assurance Department, 165 Hymus Blvd, Pointe-Claire (Quebec), Canada H9R 1E9** or by telephone at **1-800-405-5320**.

© 2017 Leviton Mfg. Co., Inc.

DI-000-DD710-02A

### LIMITED 5 YEAR WARRANTY AND EXCLUSIONS

Leviton warrants to the original consumer purchaser and not for the benefit of anyone else that this product at the time of its sale by Leviton is free of defects in materials and workmanship under normal and proper use for five years from the purchase date. Leviton's only obligation is to correct such defects by repair or replacement, at its option. For details visit [www.leviton.com](http://www.leviton.com) or call 1-800-824-3005. This warranty excludes and there is disclaimed liability for labor for removal of this product or reinstallation. This warranty is void if this product is installed improperly or in an improper environment, overloaded, misused, abused, or altered in any manner, or is not used under normal operating conditions or not in accordance with any labels or instructions. There are no other or implied warranties of any kind, including merchantability and fitness for a particular purpose, but if any implied warranty is required by the applicable jurisdiction, the duration of any such implied warranty, including merchantability and fitness for a particular purpose, is limited to five years. Leviton is not liable for incidental, indirect, special, or consequential damages, including without limitation, damage to, or loss of use of, any equipment, lost sales or profits or delay or failure to perform this warranty obligation. The remedies provided herein are the exclusive remedies under this warranty, whether based on contract, tort or otherwise.